



བགྲིས་བཅད་དོན་བརྒྱུད་འབྲེལ་ཚད་འཛིན།།

Tashi InfoComm Limited

TASHI INFOCOMM LIMITED

BIDDING DOCUMENT FOR SUPPLY OF

“Power & Utilities Equipment for FY-2023”

Reference No: TICL/PRO-08/2023/147

Date: 28 / 01 / 2023

Procurement Officer
Procurement & Inventory Section
Tashi InfoComm Ltd.
Thimphu : Bhutan

Address: P.O Box # 1502, Norzin Lam, Thimphu: Bhutan
Phone: +975 77889977 website: www.tashicell.com



བགྲིས་བརྗོད་བརྒྱུད་འབྲེལ་ཚད་འཛིན།།

Tashi InfoComm Limited

SECTION-I INVITATION OF BIDS FOR SUPPLY OF

“Power & Utilities Equipment for FY-23”

1. Tashi InfoComm Limited hereinafter referred to as “**Purchaser**” invites sealed bids from eligible Bidders for the supply of power and utilities equipment for FY-23.
2. Interested eligible bidder(s) may obtain further information on the bid form directly from our website- www.tashicell.com or Procurement & Inventory Section, Samten Lam, Post Box No. 1502, Thimphu, Bhutan. Contact Procurement & Inventory Section at the given contact details during office hours only.
3. The Purchaser shall not be responsible for any costs or expenses incurred by the Bidder(s) in connection with the preparation or delivery of bids.
4. All Bidders/Representatives of the Bidders may be present during the opening of the Bidding Documents.
5. All correspondences with regard to the Bidding Documents shall be made in writing or email to the following address. Telephone enquires shall not be accepted.

Address for communication/contact.

Procurement & Inventory Section,
Tashi InfoComm Limited,
Samten Lam, Post Box No-1502,
Thimphu, Bhutan.

Email:

procurement@tashicell.com/manager.procurement@tashicell.com/manager.power@tashicell.com/procurement.finance@tashicell.com

Procurement Officer
Procurement & Inventory Section
Tashi InfoComm Ltd.
Thimphu : Bhutan



བགྲིས་བཅ་དོན་བརྒྱད་འབྲེལ་ཚད་འཛིན།།

Tashi InfoComm Limited

SECTION-II INSTRUCTION TO BIDDERS

A. GENERAL

1. Scope of Bid:

- 1.1. The scope of Bid shall be the supply of power and utilities equipment for the FY-2023.
- 1.2. All the Bids are to be completed and submitted to the Purchaser in accordance with the Instruction to Bidders.

2. Eligibility:

- 2.1. The invitation for Bid is open to all the interested licensed national and global suppliers.

3. Cost of Bidding:

- 3.1. The Bidder(s) shall bear all costs associated with the preparation and delivery of its bids, and the purchaser shall in no case be responsible or liable for those costs.

4. Bidding Documents:

- 4.1. The goods/services to be procured, bidding procedures, and terms & conditions are prescribed in the Bidding Documents. In addition to the invitation for bids, the bidding document includes:
 - a) Instructions to bidders
 - b) General terms & conditions
 - c) Detail list of goods/ and or services to be supplied along with detailed specifications.
- 4.2. The bidder(s) are expected to examine the bidding document, including all instructions, forms, terms, and specifications. Failure to furnish all information required by the bidding document or submission of a bid not substantially responsive to the bidding document in every respect will result in rejection of the bid.

5. Bid Prices:

- 5.1. The bidder(s) shall complete the appropriate price schedule included herein, stating unit prices, extended amount and the expected countries of origin of the goods to be supplied, if applicable
- 5.2. Prices quoted by the bidders shall remain fixed and valid for the period stated in **Section-II, Clause 6** of the bidding document, and will not be subject to variation on any account.
- 5.3. The bid currency shall be Ngultrum (Nu) for this bidding document. Except for third country bidder(s), the bidder(s) from the rest of the countries are not allowed to quote in US Dollar.



བགྲིས་བརྒྱ་དོན་བརྒྱུད་འབྲེལ་ཚད་འཛིན།།

Tashi InfoComm Limited

The third country bidder(s) who quoted in US Dollar shall be converted into Ngultrum at the prevailing exchange rate (Selling TT rate of any financial institution) as on the date of tender opening for evaluation purpose.

5.4. Trade Terms shall be:

Unless otherwise stated, the following shall be the trade terms for this bidding document:

- a) CIF, TICL Warehouse, Thimphu for local bidders.
- b) CIF, TICL Warehouse, Phuentsholing for Indian and other third-country bidder(s).

6. Bid Validity:

- 6.1. The Bids shall be valid for 12 months from the date of bid submission.

7. Taxes/Duties & other levies:

- 7.1. Unless otherwise stated, the applicable taxes/duties/any other levy both within and outside Bhutan shall be under the scope of the bidder.
- 7.2. The third country bidder(s) or bidder(s) from India may exclude applicable taxes/duties within Bhutan while submitting the bid. The applicable taxes including customs clearance within Bhutan shall be under the scope of the purchaser. However, applicable taxes/duties, etc shall be factored in during the time of evaluation to determine the final landing cost.

8. Evaluation:

- 8.1. The purchaser shall evaluate the quotations based on specifications given in the bidding document to ascertain the lowest evaluated bidder(s).
- 8.2. The evaluation shall not only be based on the quoted unit rate but the specifications and complete datasheet of the power and utilities equipment against the purchaser's requirement.
- 8.3. The Evaluation Team & Management Tender Committee's evaluation decision shall be final and binding, without thereby incurring any liability to the affected bidder or bidders or any obligation to inform and explain the affected bidder or bidders on the grounds of the evaluation team & Management Tender Committee's evaluation decisions and reports. In addition, the performance of previous tenders with the purchaser, if any shall also be factored in during the time of evaluation.
- 8.4. The lowest quoted unit rates alone do not guarantee the award of contract or Purchase Order.
- 8.5. The evaluation shall be based on the "single package".

Procurement Officer
Procurement & Inventory Section
Tashi InfoComm Ltd.
Thimphu : Bhutan

Address: P.O Box # 1502, Norzin Lam, Thimphu: Bhutan
Phone: +975 77889977 website: www.tashicell.com



བགྲིས་བཅད་དོན་བརྒྱུད་འབྲེལ་ཚད་འཛིན།།

Tashi InfoComm Limited

9. Award of Purchase Order/Contract:

9.1. The purchaser shall award the PO or supply contract to the successful bidder.

10. Delivery:

10.1. Delivery should be completed as per the given schedule:

- a) Within 60 days from the date of confirmed PO depending on the nature of the items(s) awarded to the respective successful bidder(s).
- b) The detailed terms & conditions shall be mentioned in the confirmed Purchase Order/Supply Contract.

10.2. The purchaser (TICL) may provide delivery time extension beyond the actual delivery date taking into account the actual need-by-day and project schedule of TICL. However, subject to the approval of the Management Tender Committee after levying the Liquidity Damaged (LD) Penalty.

10.3. The Time Extension request/provided may not exceed 15 days at the maximum OR depend on the approval granted by the Management Tender Committee of the purchaser. The supplier has to send an email/in writing requesting a time extension with genuine reasons (along with supporting documentation).

11. Inspection of Goods:

11.1. The goods are subject to Physical Inspection upon delivery at TICL Warehouse and testing & commissioning in due course of time. The Goods found to be faulty, DOA, not meeting specifications/requirement of TICL after the final inspection, installation, and testing shall be rejected at the cost of the bidder.

12. Warranty (If applicable):

12.1. The Warranty shall be minimum 12 months from the date of delivery OR standard manufacturer's warranty, whichever is longer

13. Payment:

13.1. The Payment shall be made 100% against delivery within 7 working days from the date of receiving of Bill/Invoice.

13.2. Advance payment up to a maximum of 30% of the total PO value may be released at Purchaser's discretion against furnishing equivalent amount of bank guarantee for the advance payment valid 6 months beyond the delivery deadline.



བགྲིས་བརྒྱ་དོན་བརྒྱུད་འབྲེལ་ཚད་འཛིན།།

Tashi InfoComm Limited

14. TDS/FCT:

14.1. TDS (Tax Deduction at Source) and or FCT (Foreign Contract Tax) shall be deducted as per the existing Rules and Regulations of the Department of Revenue & Customs, Bhutan (wherever applicable).

15. EMD (Earnest Money Deposit):

- 15.1. The bidder should submit **not less than 2% of the total quoted value** as part of the EMD along with the quotation in the form of Demand Draft or Bank Guarantee from any of the financial institutions located in Bhutan. The bidder(s) other than Bhutanese national can furnish EMD from the financial institutions in their respective countries OR from any of the Bhutanese Financial Institutions. The EMD may be directly deposited into the Purchaser's bank account (please contact the purchase requesting for bank details via email).
- 15.2. The bidder(s) failing to submit the EMD as per the requirement shall result in the rejection/cancellation of their bid.
- 15.3. The EMD shall be valid for 60 days beyond the submission/submission deadline of the bidding document. The EMD should be drawn in favor of "**Tashi InfoComm Ltd., Samten Lam, Thimphu, Bhutan**".
- 15.4. EMD of unsuccessful bidder(s) shall be returned promptly after the finalization of the quotation.
- 15.5. EMD shall be forfeited if:
- A bidder withdraws its bids prior to the finalization of the bids in every respect.
 - The successful bidder fails to submit Performance Security as per the terms specified in the bidding document.
- 15.6. EMD of the successful bidder shall be returned promptly upon submission of Performance Security.

16. Performance Security:

- 16.1. The successful bidder should submit not less than 10% of the total PO/contract value as Performance Security within 1 week from the date of PO/signing of the supply contract.
- 16.2. Performance Security shall be drawn in favor of "**Tashi InfoComm Ltd, Thimphu**" in the form of Demand Draft or Bank Guarantee or can be deposited directly into the purchaser's bank account (contact purchaser via email requesting bank details).
- 16.3. Performance Security shall be valid for the period of **1 YEAR** from the date of Purchase Order/Supply Contract.



བགྲིས་བཅད་དོན་བརྒྱད་འབྲེལ་ཚད་འཛིན།།

Tashi InfoComm Limited

- 16.4. If the successful bidder fails to submit the performance security within 1 week, the EMD shall be forfeited and purchase order shall stand cancelled and awarded to the second lowest evaluated bidder.
- 16.5. Performance Security shall be returned within 1 week from the date of successful completion of all obligations under the issued Purchase Orders or signed supply contract.
- 16.6. Performance Security shall be forfeited if:
- The successful bidder fails to execute the supplies/works as per the terms and conditions stated in the purchase order in any manner deemed unsatisfactory by the purchaser (TICL) or the end-user(s).
 - The successful bidder fails to deliver the goods on the given deadline and is not recommended by the end-user(s) for a time extension or replacement.
 - The goods supplied do not conform to the specifications/brands/requirements, etc stated in the purchase order/BOM.

17. Liquidity Damage (LD) Penalty:

- 17.1. The LD penalty shall be charged at 0.01% per day up to a maximum of 10% of the total PO value should the supplier fail to deliver on the specified deadline.

18. The purchaser Right:

- 18.1. The purchaser reserves the following rights without thereby incurring any liability to the affected bidder or bidders or any obligation to inform and explain the affected bidder or bidders on the grounds of the purchaser's action:
- The right to accept or reject any bid and reject all the bids at any time prior to issuance of Award Notification and or Purchase Order.
 - The right at the time of award of the purchase order to increase or decrease the quantity of goods specified in the bidding document, without any changes in the price or other terms & conditions.
 - The right to reject all or in part, the item supplied during the time of physical inspection/testing or found to be non-standard/non-specific/unreliable in terms of quality/not meeting specification.
 - The right to direct negotiation, call quotations and receives the same via email from the manufacturers; authorized distributors; authorized dealers; frequent supplier(s) of similar goods in Bhutan/India/China/Other countries to compare the rates with those offered by the vendors through this Bidding Document. If need be, to procure directly. The Purchaser also reserves the right to negotiate with the lowest evaluated bidder(s) or all of the bidders at any time prior to award of Purchase Order/Signing of Supply Contract.



བགྲིས་བརྗོད་བརྗོད་འབྲེལ་ཚད་འཛིན།།

Tashi InfoComm Limited

18.2. Should the selected Bidder(s) fail to supply full order quantity within the given deadline, the purchaser reserves the right to cancel the quantities not supplied and place the order to the Second Lowest Evaluated Bidder. In such a case, the Purchaser shall recover as part of Liquidated Damages, the difference amount between purchase order rate and the actual rate paid to the second-lowest evaluated bidder for the quantities not supplied. The amounts shall be either adjusted from the Performance Security or bill/invoice amount of the supplied quantity.

19. Force majeure:

19.1. Force Majeure shall mean such unforeseeable occurrences beyond the control of the Purchaser and Bidder which occur after the date of issuance of Purchase Order or signing of Supply Contract and which were not reasonably foreseeable at the time of issuance of Purchase Order or signing of Supply Contract and which effects are not capable of being overcome without the unreasonable expense and/or loss of time to the Purchaser and the Bidder concerned, including, provided that the aforementioned conditions are met, but not limited to:

- i) Natural catastrophes, earthquakes
- ii) Strikes and blockages
- iii) War or war-like conditions, mobilizations, revolutions or riots, an act of Public enemy, sabotage, terrorism.
- iv) Restriction by or actions, omissions, or interventions from Public Authorities (including but not limited to changes in laws, regulations or import/export, security restrictions).
- v) The Party who wishes to plead Force Majeure shall inform the other party of the First party's perception of the effects of such force majeure on the fulfillment of issued purchase order/signed Supply Contract. Should any event of force majeure cause an increase in the time required for the performance of any part of the purchase order/signed Supply Contract, an equivalent adjustment shall be made in the time required for performance.

However, if the force majeure situation continues for more than two months, the purchaser and bidder shall decide whether the contract should be terminated.

20. Termination:

20.1. In the event of any failure by the Bidder to perform any of its obligations under the issued purchase order or signed Supply Contract or upon unsatisfactory performance, the purchaser shall terminate the purchase order or signed Supply Contract by giving a prior written notice of Fifteen (15) days, without any obligation to the Bidder. However, the purchaser shall pay the actual due amount for the quantity supplied and accepted by the Purchaser to Bidder on termination of the issued purchase order or signed Supply Contract.

21. Indemnity:

21.1. The bidder(s) shall comply with all the laws in force in Bhutan and outside. The laws will include all national, provincial, municipal, or other laws that affect the performance of the issued purchase orders or signed Supply Contract and bind upon the Bidder(s). The Bidder(s)

Address: P.O Box # 1502, Norzin Lam, Thimphu: Bhutan
Phone: +975 77889977 website: www.tashicell.com

Procurement Officer
Procurement & Inventory Section
Tashi InfoComm Ltd.
Thimphu : Bhutan



བགྲིས་བཅད་དོན་བརྒྱད་འབྲེལ་ཚད་འཛིན།།

Tashi InfoComm Limited

shall indemnify and hold harmless the Purchaser for and against any and all liabilities, damages, claims, fines, penalties, and expenses of whatever the nature arising or resulting from the violation of such laws by the Bidder(s).

22. Dispute Settlement:

- 22.1. If any dispute should arise in connection to the issued purchase order or signed Supply Contract, the Parties shall try to settle any such dispute through good faith and negotiations including escalation to senior Management where each party deems it appropriate. If negotiations fail, the matter shall be referred to the Court of Law.

23. Governing Law and Jurisdiction:

- 23.1. The terms and conditions in this Bidding Document or issued Purchase Order or signed Supply Contract shall be read and construed in accordance with the laws of the Kingdom of Bhutan and the District Court of Thimphu, Bhutan shall have jurisdiction over any disputes arising out of the Contract.



བགྲིས་བརྗོད་བརྒྱུད་འབྲེལ་ཚད་འཛིན།།

Tashi InfoComm Limited

SECTION-III GENERAL TERMS & CONDITIONS:

In this Bidding Document, the following terms shall be interpreted as indicated below:

“**The Bid**” means the proposal submitted by the Bidder

“**The Purchaser**” means the organization purchasing the Goods. In this case, M/s. Tashi InfoComm Limited (TICL).

“**Day**” means a calendar day.

1. **Bid Submission:** The Bids should be submitted in a sealed envelope (Single Envelope Method- **copy not required**) addressed to “ **Procurement & Inventory Section, TICL** against Reference No...TICL/PRD-08/2023/147..... dated ...28/01/2023.....”.
2. **Bid Submission:** ..15/02/2023..... (Bhutan Standard Time); ...11:00 AM.....
3. **Bid Opening Time:** 2:00 PM : 15/02/2023 at TICL conference hall. Interested Bidder(s) may attend the bid opening on the given deadline and place.
4. Bidding Document received after the deadline (time & date of submission) shall not be accepted and opened during the bid opening. The quotations shall automatically stand as “Rejected”.
5. The Purchaser shall not be responsible for any damages, losses, breakages, or shortages of any items while in transit for delivery of Goods to TICL Store/warehouse.
6. The Bidder should enclose a Xerox copy of valid Trade License, Tax clearance, Power of Attorney, and other relevant documents.
7. **Clarification on Bidding Document:** The bidder(s) are expected to examine the Terms and Conditions stated in the Bidding Document, Bill of Materials, Specifications, Drawings, etc furnished along with the Bidding Document. Once the bids are submitted by the bidder(s), It shall mean:
 - a) The bidder(s) have examined, read, and accepted all the terms and conditions stated in the Bidding Document, the specifications of the goods/services, Drawings/Designs, etc furnished in the Bidding Document. Thereafter, no grievance, complaints, etc (whatsoever nature may be) shall be accepted.
 - b) The bidder(s) can seek clarification (through email/in writing) with regard to the terms & conditions of the Bidding Document, the specifications of the goods/services, Drawings/Designs, etc furnished in the Bidding Document before the submission of the Bids.

Procurement Officer
Procurement & Inventory Section
Tashi InfoComm Ltd.
Thimphu : Bhutan

Address: P.O Box # 1502, Norzin Lam, Thimphu: Bhutan
Phone: +975 77889977 website: www.tashicell.com



བགྲིས་བཅད་དོན་བརྒྱུད་འབྲེལ་ཚད་འཛིན།།

Tashi InfoComm Limited

- c) Clarification can be sought through email or in writing to any of the given officials during office hours. Email ID: manager.procurement@tashicell.com OR procurement.finance@tashicell.com OR procurement@tashicell.com.

Address: Manager, Procurement & Inventory Section, Tashi InfoComm Ltd., Norzin Lam, Post Box No. 1502, Thimphu, Bhutan.

8. The Bids not substantially responsive to the Bidding Document in every respect will result in rejection of the Bids.
9. For any complaints or grievances, the bidder(s) may write directly to the Management Tender Committee of the Purchaser through email. The Email ID is procurement@tashicell.com.
10. Product samples, catalog/brochures containing details technical and functional specifications shall be submitted along with the Bids wherever applicable. Failing which, shall result in rejection of the Bidding Document.
11. The decision of the Corporate/Management Tender Committee shall be final and binding.

Procurement Officer
Procurement & Inventory Section
Tashi InfoComm Ltd.
Thimphu : Bhutan



བགྲིས་བརྗོད་བརྒྱུད་འབྲེལ་ཚད་འཛིན།།

Tashi InfoComm Limited

SECTION-IV

The complete **Bill of Materials (BOM)** is as stated in **Annexure-I**. The Bids should be submitted in the below format in your company Quotation Form.

Appendix-I:

S/L	Description	UoM	Qty	Unit Rate	Amount
1.	1. Detail as given in Annexure-I				

Total

Note:

1. Please attached details of the technical and functional specification along with Bidding Doc. Failing to do so, will result in the rejection of your bidding document.
2. Mention the Country of origin of goods in the bidding document.

Procurement Officer
Procurement & Inventory Section
Tashi InfoComm Ltd.
Thimphu : Bhutan

Annexure- I BOQ & Price Schedule

SL	Description	UoM	Qty	Rate	Amount
1	Drilling machine (Bosch/Makita)	Nos	11		
2	RJ45 Crimper (Schneider/Proskit)	Nos	30		
3	Mini ducting rod	Nos	1		
4	Rivet Gun (Makita)	Nos	1		
5	Aluminium telescopic ladder	Nos	1		
6	Partable LED lamp	Nos	2		
7	Walkie Talkie	Nos	3		
8	1.5 ton split type air conditioner R-32, Brand: Daikin, 5 star rating	Set	33		
9	Clamp meter (DC metering support) Proskit MT-3109 AC/DC digital clamp multimeter	Nos	15		
10	Ratchet set Brand: JK	Nos	14		
11	Jerry can, 40 ltr capacity	Nos	195		
12	Cable lugs crimper	Nos	20		
13	2x50 sqmm ABC cable Brand: Anvil	Mtrs	4000		
14	2x35 sqmm UG cable Brand: Anvil	Mtrs	1000		
15	Energy meter enclosure Model no. KG 9003	Nos	25		
16	Earth tester (Proskit 8 PK-ST 1520 digital earth resistance tester)	Nos	2		
17	Safety belt with work positioning belt lanyard with grip adjuster (2 M	Nos	10		
18	Pulley	Nos	5		
Total in Nu					

Procurement Officer
Procurement & Inventory Section
Tashi InfoComm Ltd.
Thimphu : Bhutan

Technical Specification of the Fiber Tools.

1. Splicing Machine High end (Sumito/ Fujikura)-Specification & Catalogue attached
2. Active V-Groove Fusion Splicer (Sumito/ Fujikura)-specification & catalogue attached

Sl. No	Product	Brand	Types
1	Splicing machine High end	Sumitomo	82C
	Splicing machine High end	Fujikura	FSM 66S+
2	Splicing machine FTTx	Sumitomo	T-400S
	Splicing machine FTTx	Fujikura	FSM 28S

3. OTDR ((EXPO/ Fujikura)-specification & catalogue attached

Sl. No	Product	Brand	Features
3	OTDR	EXFO	MaxTester 730C PON/metro OTDR
	OTDR	Fujikura	FlexScan® FS200 SM OTDR

4. Drilling Machine

Technical Details

Brand:	Bosch/Makita
Manufacturer:	Bosch/Makita
Colour:	Blue
Item Weight:	3 kg 440 g
Product Dimensions:	35 x 29.4 x 9.9 cm; 3.44 Kilograms
Batteries:	2 Lithium ion batteries required.
Item model number:	GSB 180-LI
Item Height:	9.9 Centimeters
Item Width:	29.4 Centimeters
Voltage:	18 Volts
Power source type :	Battery Powered
Included Components:	Tools
Lithium Battery Energy Content:	5 Watt Hours
Lithium Battery Packaging:	Batteries contained in equipment
Lithium Battery Weight:	50 Grams



Technical Specifications

Battery voltage	18 V
No-load speed	0 – 500 / 0 – 1,900 rpm
Chuck capacity, min./max.	1.5 / 13 mm
Torque settings	20+2
Torque (soft/hard/max.)	21/54/- Nm
Battery type	Lithium-ion
Max. impact rate	27,000 bpm
Max. drilling diameter in wood	35 mm
Max. drilling diameter steel	10 mm
Max. drilling diameter masonry	10 mm
Max diameter	10 m

5. RJ45 Crimper (Schneider)- Specification & Catalogue attached

6. Portable Mini Ducting Rod

Item	Rod diameter	Bend radius	Rod length	Conduit diameter	Frame size
7	10 mm	178 mm	150 meter	10 cm	87 cm × 92 cm × 40 cm

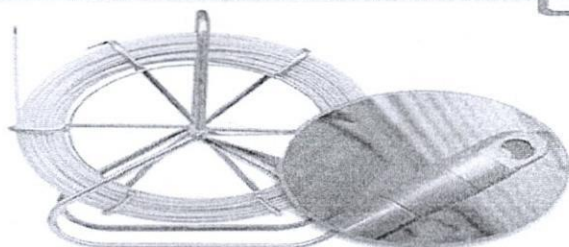

Handwritten initials or signature in blue ink.

Component parts:

1. Frame.
2. Rubber wheel.
3. Pulling rod.
4. Hand-operated brake.
5. Hydraulic compression copper head
6. Rod guide.
7. Grip.

Material:

- **Internal wire:** copper or steel.
- **Inner rod:** fiberglass.
- **Exterior coating:** UV resistance polyethylene.
- **Wheel:** rubber, steel.
- **Drawing head:** copper.
- **Frame:** steel.

Frame finish: powder coated, zinc plated.

Specification:

- **Rod diameter:** 10 mm.
- **Length of fiberglass rod:** 150m.
- **Working temperature:** -40°C to + 80°C (-40°F to 176°F).
- **Minimum bend radius:** 4" (That is for 4mm rod diameter, other rods with larger diameter have larger bend radius).
- **Max pulling strength:** 4.5T (For rod diameter 16mm, other rods with smaller diameter have less pulling strength).
- **Fiberglass rod color:** yellow, blue, white, red, black.
- **Package:** plastic wrap and then into carton.

Features:

- Light weight, high tensile strength.
- Polyethylene coating for good electric insulativity, smooth surface, resistance to acid and corrosion.
- Elastic body for easy passing through narrow pipes and bending conduits.
- Copper wire inside for tracing if needed.
- Good friction and heat resistance allow the rod to travel longer distance in the conduits and to be operated in harsh environment.
- Meter marks on the protective layer of the rod for measuring distance, printed by professional printing machine.
- Waterproof and anti-ultraviolet for durable use.
- Hand operated brake for controlling payout of the pulling rod. The rotating and stopping of the rod can be easily controlled by the brake.
- Some frames are double-barreled reinforcement design for a more sturdy structure.
- Small bending radius allows the rod itself passing through tight bends in the ducts



7. Cordless Rivet Gun

18V Brushless Cordless Rivet Gun

- Jaw Case Designed to Enable Tight Space Operation
- The short center height allows for tight space operation such as close-to-wall riveting
- Compatible with various sizes of blind rivets
- A wide range of nose pieces and jaw pushers allow for tightening various sizes of blind rivets
- Compatible rivet diameter: ø4.8mm, ø6.0mm, ø6.4mm
- High speed tightening; Able to tighten rivets as fast as the competitors
- Rivet holding mechanism; Once a rivet is installed, it is held in place and do not drop out even when the tool is directed downward; No need for holding the rivet by hand even in vertical down application
- Transparent mandrel container; The amount of spent mandrels can be checked
- BL motor delivers 20 kN of max pulling force
- BL motor eliminates carbon brushes, enabling the BL motor to run cooler and more efficiently for longer life
- Twin LED job light with pre-glow and afterglow functions illuminates the work area
- Electric brake for maximum productivity
- Extreme Protection Technology (XPT) is engineered for improved dust and water resistance for operation in harsh conditions
- Battery protection circuit protects against overloading, over-discharging and over-heating

Pulling Force: 20 kN (4,500 lbs.)

Stroke: 30 mm (1-3/16")

Rivet Diameter range: 2.4 – 6.4 mm (3/32" – 1/4")

Center Height: 26 mm (1")

Max Output: 360 W

Vibration level: 2.5 m/s² or less

Vibration K Factor: 2.5 m/s²

Sound pressure level: 74 dB(A)

Noise K Factor: 3 dB(A)

Dimension (L x B x H):

Net weight: 2.1-2.4 kg (4.6 – 5.3 lb)

8. Aluminium Ladder

Sl. No	Product	Brand	Types
9	Aluminium ladder	Corvids	Corvids 6.2m (20.5 ft) Portable & Compact Aluminium Telescopic Ladder, EN131 Certified, 16-Steps Foldable Multipurpose Collapsible Ladder for Home & Outdoor use

9. Fiber Optics Tool kit

Sl. No	Product	Brand	Types
10	Fiber Optics Tool Kit	Any Brand	

10. Portable LED Lamp

Sl. No	Product	Brand	Types
11	Portable LED Lamp	Voroly	Portable bright work light, battery charger, emergency gear, indoor lights, outdoor security lights, Work light, 30W 24LED super bright LED work lights, bright enough. With 2 Blue and 2 Red Flashing LEDS, the best gear in a roadside emergency.

11. Walkie Talkie.

Sl. No	Product	Brand	Types
12	Walkie Talkie	Motorola	SMP818





SMP 818

Portable Two Way Radio with the Most Functions

(SL-12)

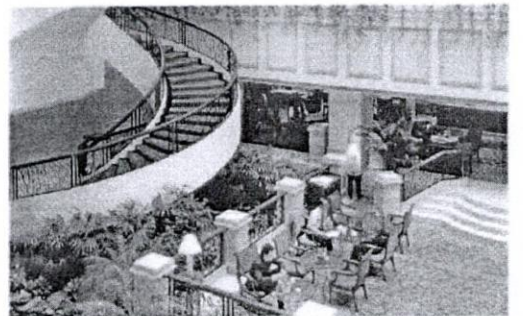

Efficient communication
Changing to Meet Your Demand

Handwritten mark

Shanghai Motorola Telecom Products Co.,Ltd.

Handwritten mark

Main Features

Ch/Freq/Mem Mode
 Numeric Keypad
 5 Programmable Keys
 Voice Compander/Scrambler
 PTT ID Display
 DTMF Encode & Decode
 Primary/Group ID
 DTMF Auto Dial List

VOX/Sensitive/Delay
 Remote Stun/Disable
 9 Squelch Levels
 Frequency Step/Offset
 Frequency Reverse
 Baudwidth Selectable
 FM Radio
 LED Flashlight

Standard Accessory

1100mAh Li-ion Battery



Charger Base



Power Adapter
 (EU/UK/US/3C)



Antenna



Technical Specification

General Specification	SMP818
Frequency Range*	U01: 400~470MHz U03: 435~480MHz U04: 330~400MHz V01: 136~174MHz
Channel Capacity	128
CTCSS/CDCSS	51/107
Channel Space	25KHz/12.5KHz
Operation Temp. Range	-20°C~+55°C
Dimension(H×W×T)	98×53×30mm
Weight(include battery and antenna)	205g
Power Supply	DC 7.4V
Battery Life(5/5/90 duty cycle)	≥8hours

Receiver

Sensitivity(12 dB SINAD)	-119dBm(0.25μV)
Adjacent Ch Selectivity	65dB@25KHz
Intermodulation	≥60dB
Hum and Noise	≥40dB@25KHz
Spurious Response Rejection	60dB
Blocking	≥85dB
Audio Distortion	≤5%
Audio Power Output	430mW@8Ω

Hand Strap



Belt Clip



Optional Accessory

1500mAh Li-ion Battery



PTT Earpiece



Transmitter

RF Power Output	H:4-5W / L:1W
Frequency Stability	±2.5 PPM
FM hum and Noise	≥40dB@25KHz
Modulation Limited	≤±5.0KHz@25KHz
Adjacent Ch Power	65dBc
Modulation Character	±3dB
Spurious and Harmonics	≤7.5μW
Audio Distortion	≤5%

PC Encoder Cable



Frequency Availability is limited by National laws and regulations.
 Above specifications are all typical configuration values,
 they may be subject to variations without notice

(For reference only)

Shanghai Motorola Telecom Products Co., Ltd.

SMP is trademark of Shanghai Motorola Telecom Products Co., Ltd. Copyright Reserved.
 MOTOROLA is trademark of Motorola © Copyright 2010 Motorola Inc. All Rights Reserved



བགྲིས་བཅད་དོན་བརྒྱན་འབྲེལ་ཚད་འཛིན།།

Tashi InfoComm Limited

1. 1.5 Ton split type air conditioners:

- Daikin Brand
- R-32 Gas
- It should have wall mounting brackets
- The tube between IDU and ODU should be pure copper
- 5-Star Ratings

2. Digital Clamp Meter

- Brand: Proskit

Model:- Proskit MT-3109 AC/DC Digital Clamp Multimeter

3. Ratchet Set:

- Brand: JK

Model No- JK Super Drive SD7800525 JKSD Hexagonal Socket Set(1/2 Inch Square Drive, 27 Pieces)

4. Jerry Can:

- Chemical Blue 40 Litre Plastic Jerry Can

Product Specification

Capacity	40 Litre
Material	Plastic
Color	Blue
Storage Material	Chemical
Thickness	7 mm
With Handle	Yes

5. Cable Lugs Crimper:

Address: P.O Box # 1502, Norzin Lam, Thimphu: Bhutan
Phone: +975 77889977 Fax: +975 2 336318 website: www.tashicell.com



བགྲིས་བཅད་དོན་བརྒྱུད་འབྲེལ་ཚད་འཛིན།།

Tashi InfoComm Limited

-HORUSDY 6-50mm² Cable Lug Crimping Tools

Brand	HORUSDY
Colour	Blue/Black/Orange
Weight	1.3 Kilograms
Item dimensions LxWxH	40.1 x 14.2 x 4.8 centimeters

About this item

- Precise crimping die sets and integral lock with self releasing mechanism to ensure high-quality crimping effects even after many times of repeatedly crimping.
- Designed according to human factors engineering, the long handle provides maximum leverage and easier closing. Anti-slip grips with finger grooves for safe handling.
- Made of hardened carbon steel with hexagonal type, it works for bare cable of 6-50 mm²;capacity.
- Profiles can be set by turning the crimping handle with a wide degree, which allows access to hard to reach areas.
- Compact, lightweight, easy to use and carry,

6. ABC Cable:

- 2x50sqmm ABC Cable
- Brand: Anvil Cable
- The technical details are attached

7. UG Cable:

- 2x35 sqmm UG cable
- Brand: Anvil
- The technical details are attached

8. Energy Meter Enclouser:

- Energy Meter Enclosure with din rail and 63amps Double Pole MCB (DP)
- HENSEL Make,
- Model No:KG9003,
- IP65 Protection,

Address: P.O Box # 1502, Norzin Lam, Thimphu: Bhutan
Phone: +975 77889977 Fax: +975 2 336318 website: www.tashicell.com



ANVIL CABLES PVT. LTD.

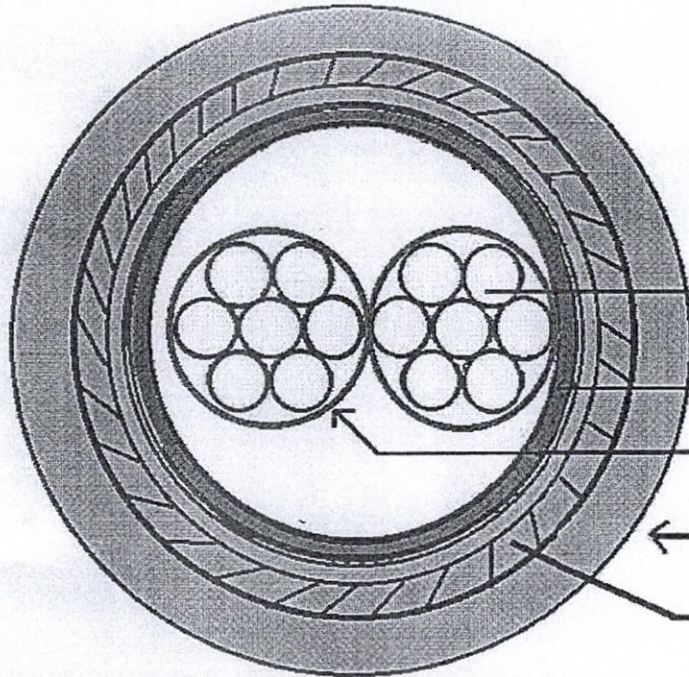

Alum. Round Conductor

PVC Inner Sheath

XLPE Insulation.

PVC Outersheath

G. Steel Strip Armouring

Handwritten mark

Handwritten mark

Handwritten signature

Handwritten mark

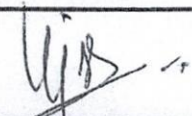
Item	Alum. Power Cable 2X35 SQ MM
Standard	IS : 7098-I
Dra. No.	ACPL/DRW/001
Signature	

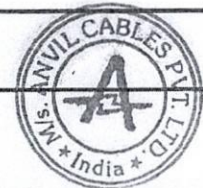

GTP OF LV 1.1 KV XLPE INSULATED ALUMINIUM POWER CABLE

Sl. No.	GTP Parameter	Unit	2C X 35 mm ²
			CODE- A2FX
1	Manufacturers Name		M/s Anvil Cables Pvt. Ltd. (INDIA)
2	Applicable Standard		As per IS: 7098 (Part -I) /1988 With latest amendment
3	ISI Registration No. and Validity date		CM/L-5900022009 Valid upto 31.03.2022.
4	Voltage Grade		1100 Volts
5	Conductor		
	a) Material & Grade		H2/H4 Grade Aluminium as per IS :8130 - 1984 With latest amendment
	b) Nos. of Core	Nos.	2
	b) Size of Conductor		
	i) Main Core	mm ²	35
	ii) Neutral Core	mm ²	35
	c) Max. D.C.Resistance of Conductor at 20 deg C (Ohm/km)		
	i) Main Core	Ohm/km	0.868
	ii) Neutral Core	Ohm/km	0.868
	d) No. of Strands / Core		
	i) Main Core	No.	7
	ii) Neutral Core	No.	7
	e) Form of Conductor		Circular Conductor
6	Insulation		
	a) Material & Grade		Type -XLPE Insulation as per IS : 7098-1988 with latest Amendment
	b) Colour of core		Red , Yellow Or As per IS : 7098-1988
	c) Nominal Thickness (mm)		
	i) Main Core	mm	0.9
	ii) Neutral Core	mm	0.9
7	Inner Sheath		
	a) Material & Type		Extruded PVC Type ST -1 Compounded as per IS 5831 -1984
	b) Minimum Thickness (mm)	mm	0.3
8	Armouring		
	a) Material & Type		Galvanized Steel Strip
	b) Nominal diameter / thickness of Armouring wire /strip (mm)	Nos. Xmm	4X0.8
9	Outer Sheath		
	a) Material & Type		Type ST-1 PVC Compound confirming IS : 5831 -1984
	b) Nominal Thickness (mm)	mm	1.40
	c) Colour of Outer Sheath		Black
10	Approximate overall diameter of cable (mm) +/- 2 mm	mm	20.00
11	Approximate net weight of cable	kg/km	700
12	Standard Drum length	Meter	500 Meter± 5%
13	Drum		
	a) Type		Suitable Non returnable Wooden Drums
	b) I.S.Reference		I.S. 10418 With latest amendment.
14	Continuous A.C current capacity (Amps)		
	a) When laid in ground (30 deg. C)	amps	92
	b) When laid in air (40 deg. C)	amps	86
15	Short Circuit rating of conductor for duration of one second in KA	KA	2.66
16	Sequential Marking		Will be provided with every meter as per NIT/TS
17	Marking on cable		ANVIL CABLES ELECTRIC 1100 V (SIZE)SQMM A2XFY MFG YR ISI
18	Bending Radius		12 x Overall diameter of cables
19)	Marking on cable drum shall carry the Information stencilled as per cl. No. 18.2 of IS : 7098 (P-1)		
20)	Continuous with stand temp. 70°C.		
21)	Short circuit with stand temp. 160°C.		

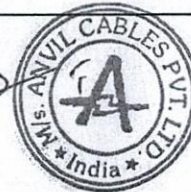

[Handwritten signature]

[Handwritten signature]

[Handwritten signature]

GTP LV AB CABLE 2X50 Sq.mm			
Sl. No.	Particulars	Unit	Offered Data
1	Manufacture Name & Address		M/s. Anvil Cables Pvt.Ltd. (India) works- AIADA large Secotor, Kandra Main Road, Gamharia, Seraikella, Jharkhand- 832108. (India)
2	Standards		IS : 14255/ BPC Standard or any equivalent.
3	Conductor Type		H2/H4 Grade Aluminium Conductor
4	Rated Cross Sectional Area	mm ²	50
5	No. of conductors	Nos.	2
6	No. of Strands	Nos.	Minimum 6
7	Service Voltage Grade	kV	1.1
8	Core Diameter	mm	7.9
9	Rated DC resistance at 20 ^o C	Ohms/km	0.641
10	Breaking Load	KN	8.45
11	Insulation Type		XLPE (Cross Linked Polyethylene) as per IS.
12	Thickness of Insulation (Nominal)	mm	1.50
13	Thickness of Insulation (Maximum)	mm	2.00
14	Drum Type		Non Returnable Wooden Drum
15	Overall Diameter of Cable	mm	21.00
16	Standard drum length	Meter	1000 Meter ± 5%
17	Minimum Volume resistivity of insulation		1 x 10 ¹³ at 27 Deg C 1 x 10 ¹⁰ at 70 Deg C
18	Temperature Coefficient of Linear Expansion		23 x 10 ⁻⁶ per °C



[Handwritten mark]

[Handwritten mark]

[Handwritten signature]

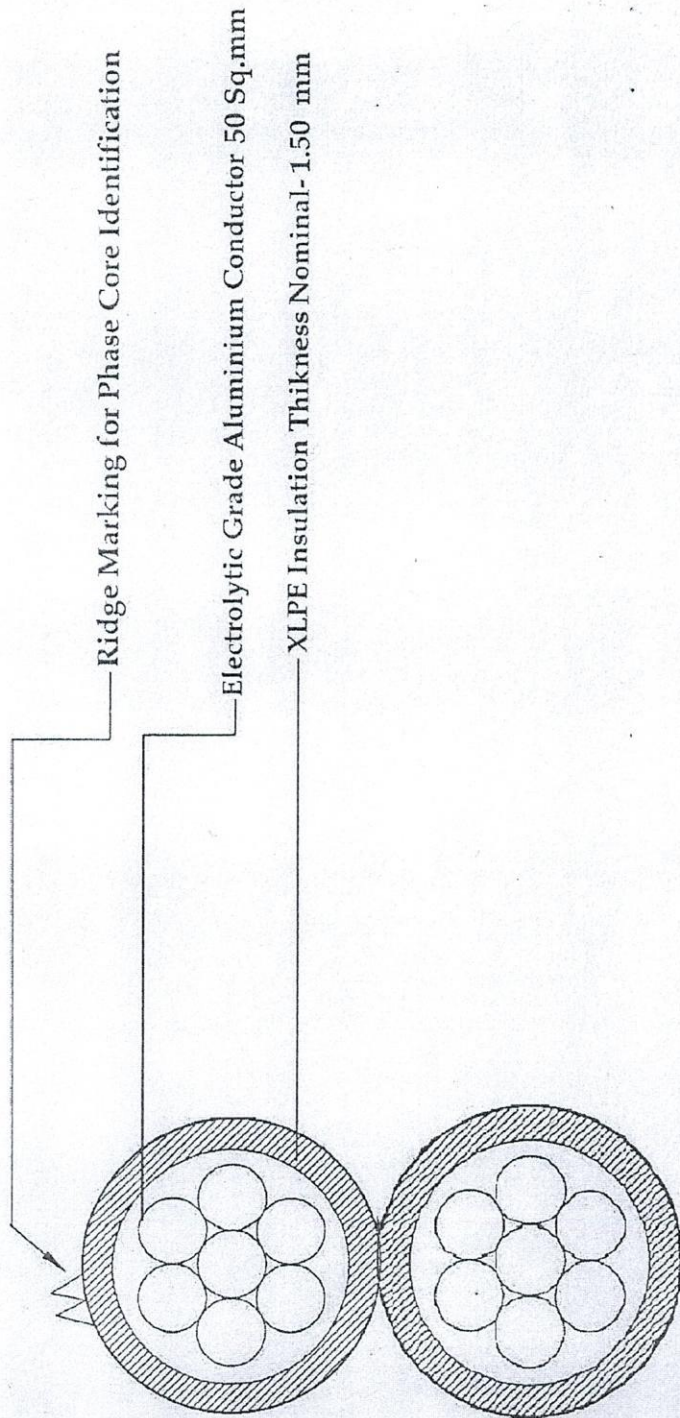

50 Sq. mm Neutral Conductor

ANVIL CABLES PVT. LTD.	
Product	ABC 2X50 SQ MM
Specification	IS 14255 Or NFC 33:209
Date	15.10.2019
Drawing Not To Scale	

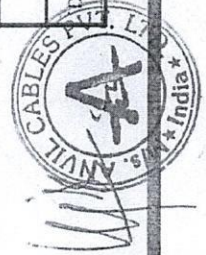

(Handwritten signatures and initials)

GUARANTEED TECHNICAL PARTICULARS FOR LT AB CABLE SIZE 2 X 50 Sq. mm

Technical characteristics	Unit	Offered Data
Name & Address of Vendor/Manufacturer		M/s. Anvil Cables Pvt. Ltd. Works- AIADA Large Sector, Kandra Main Road, Gamharia, Seraikella, Jharkhand-832108. Reg. Office- 102, Krishna, 224, AJC Bose Road, Kolkata- 700017.
Country of origin		India
Applicable Standard		IS : 14255/1995, IS: 398 Part-4, IS: 8130, IS: 10418, NFC: 33-209
Rated voltage	kV	0.6 / 1.1
Rated Frequency	Hz	50
Maximum temperature of conductor under:		
Normal operation	°C	90
Short-circuit operation	°C	250
Phase Conductor:		
Material of Insulation		XLPE
Mean Insulation thickness	mm	1.5
Material of Conductor		Aluminum
Cross Sectional Area	mm ²	50
Form		Circular and compacted
Class		2
Number of strands	Nos.	7
Diameter of wire	mm	3.0
Minimum Braking Strength	kN	7.0
Diameter conductor of Compacted	mm	7.90
Maximum resistance at 20°C	Ω/km	0.641
Insulation:		
Material of Insulation		XLPE (Cross Linked Polyethylene)
Nominal Insulation thickness	mm	1.50
Colour of Insulation		Black
Insulated Messenger Conductor:		
Material of Conductor		Aluminum alloy as per IS: 398 Part-4
Cross Sectional Area	mm ²	50
Formation of core		Circular
Minimum Number of strands		7
Diameter of wire		3.0
Diameter conductor of compacted	mm	7.90
Maximum resistance at 20°C	Ω/km	0.620
Others Details :		
Overall Diameter of the complete cable	mm	20.0 (Approx)
Packing/Wooden drum		Sea-worthy packing, Suitable as per length, Non-returnable wooden drum
Marking .		Printing or Embossing as per NIT requirement/clients requirement
Identification of core		Ridge Mark on Phase core
Length of the cable per drum	meter	1500 m ± 5% tolerance
Net Weight of Cable- Approx.	Kg/km	320
Gross weight of cable including Drum- Approx.	Kg/Drum	580

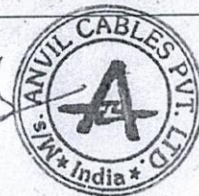

[Handwritten signature]

[Handwritten signature]

[Handwritten mark]

[Handwritten signature]



བགྲིས་བརྒྱ་དོན་བརྒྱུད་འབྲེལ་ཚད་འཛིན།།

Tashi InfoComm. Limited

2. Earth Tester (Proskit 8PK-ST1520 Digital Earth Resistance Tester)

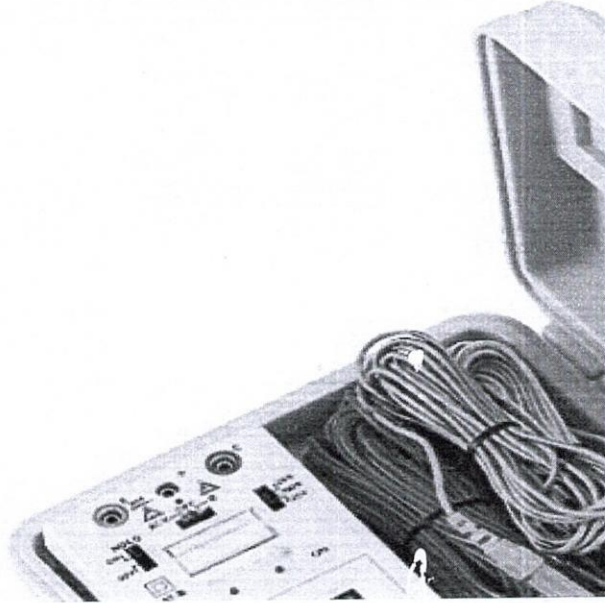

Measurement: Earth Resistance by constant current.

System: Inverter. 820Hz, 2mA approx.

Earth Voltage: 0~200V AC, 40~500Hz.

Earth Resistance Range(Resolution):0~20Ω(0.01Ω); 0~200Ω(0.4Ω), 0~2000Ω(1.0Ω).

Accuracy: Earth voltage $\pm(1\%+2d)$; Earth resistance $\pm(2\%+2d)$ or $\pm 0.1\Omega$, which is greater.

Battery: AA(1.5V)x6. (Not Included)

Size: 163x100x50mm.

Address: P.O. Box # 1502, Norzin Lam, Thimphu, Bhutan
Phone: +975 77889977 Website: www.tashicell.com



བགྲིས་བཅད་དོན་བརྒྱུད་འབྲེལ་ཚད་འཛིན།།

Tashi InfoComm Limited

3. Cable Crimping Tool

Cable Lugs Crimper:

-HORUSDY 6-50mm² Cable Lug Crimping Tools

Brand HORUSDY

Colour Blue/Black/Orange

Weight 1.3 Kilograms

Item dimensions LxWxH 40.1 x 14.2 x 4.8 centimeters

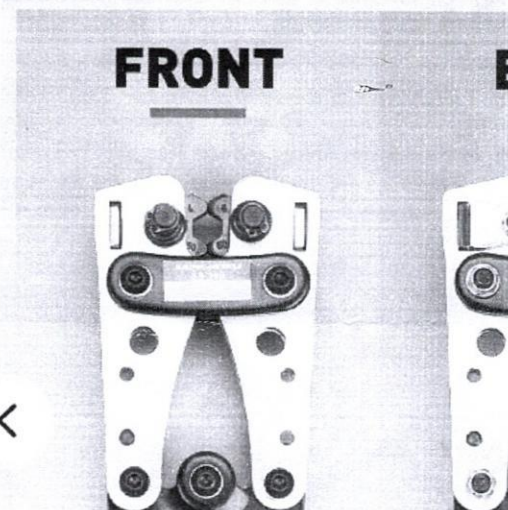



བགྲིས་བརྗེ་དོན་བརྒྱད་འབྲེལ་ཚད་འཛིན།།

Tashi InfoComm Limited

4. RJ45 Crimping Tool

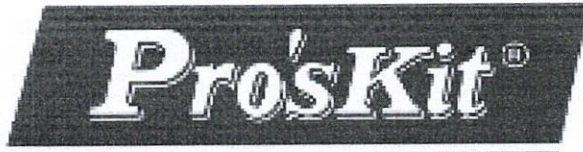

Professional Tool Solutions Since 1991

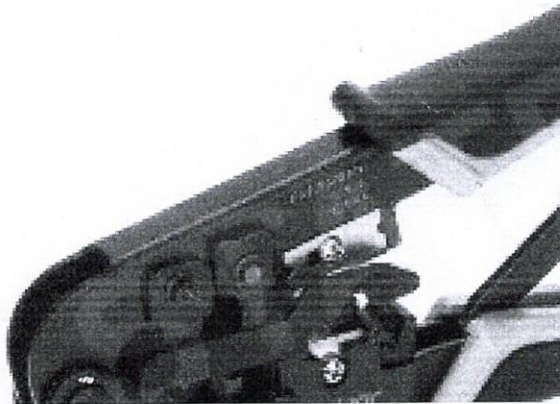



བགྲིས་བརྗེ་དོན་བརྒྱད་འབྲེལ་ཚད་འཛིན།།

Tashi InfoComm Limited

5. Safety Belt (work Positioning Belt plus work positioning Lanyard with Grip Adjuster)

Front Back

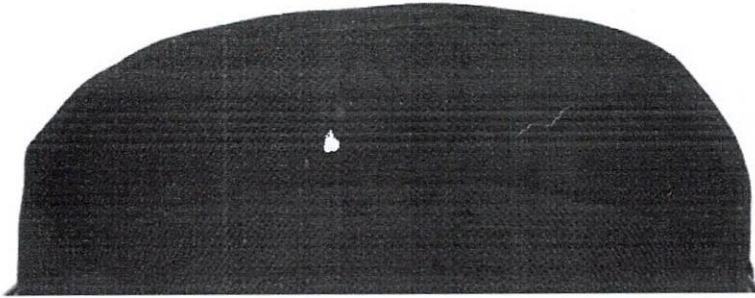

Work Posit

Ref : PN 01

- Wide comfort
- Fully Adjustabl
- Width of Back
- Two Lateral D-
- Tool holding w
- Rings for tool l

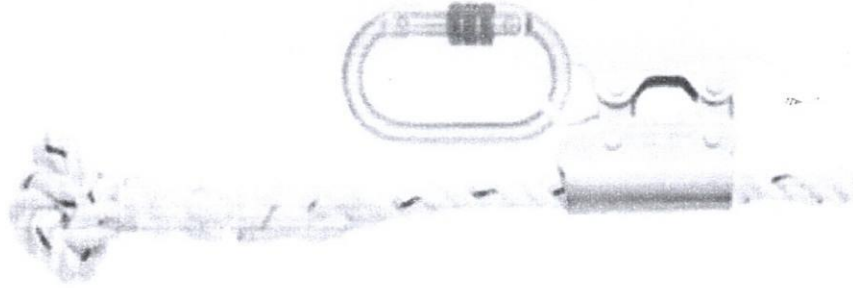

Features:

- Made of 14mm dia Polyamide 3-st Rope.
- Equipped with a convenient Rope-c easy length adjustment.
- Easy to connect Steel Karabiners F



Work Positioning Belt

Ref : PN 01

Front Back

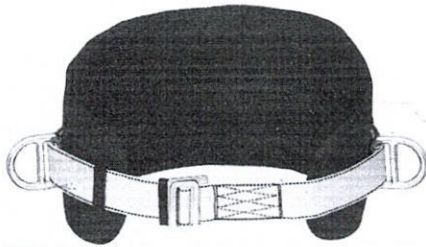

- Wide comfort pad to provide lumbar support for long working hours
- Fully Adjustable
- Width of Back Pad : 21 cms.
- Two Lateral D-Rings for Work Positioning
- Tool holding webbing loops
- Rings for tool holders, bolt bags, etc
- Available in sizes- Medium, Large, Extra Large
- Conforms to EN 358:1999

6. Pulley

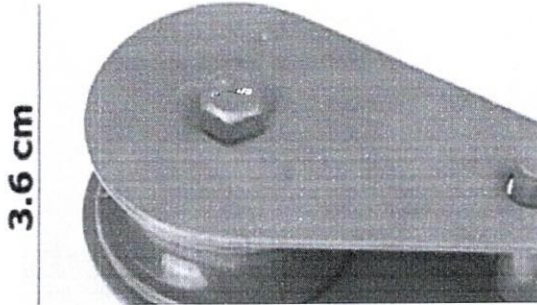

- Pulley Block with smooth turning wheel, 360 degree rotation to prevent rope/cable/wire from knotting for your convient use
- Safe & Strong load bearing; durable; anti-rust; wear & corrosion resistance; high hardness, hard to deform; deampproof.
- Workable with rope or cord indoor and outdoor for flexible sliding pulley
- Material:-Metl
- Weight Capacity-100Kg

7. 2 Men Tent



1-Bedroom, 1 Waterproof Flysheet, 2 Poles, 7 tent Pegs, 4 guy ropes, 1 cover